

Goulds Pumps

---



**ITT Industries**

**INSTALLATION, OPERATION AND MAINTENANCE INSTRUCTIONS**

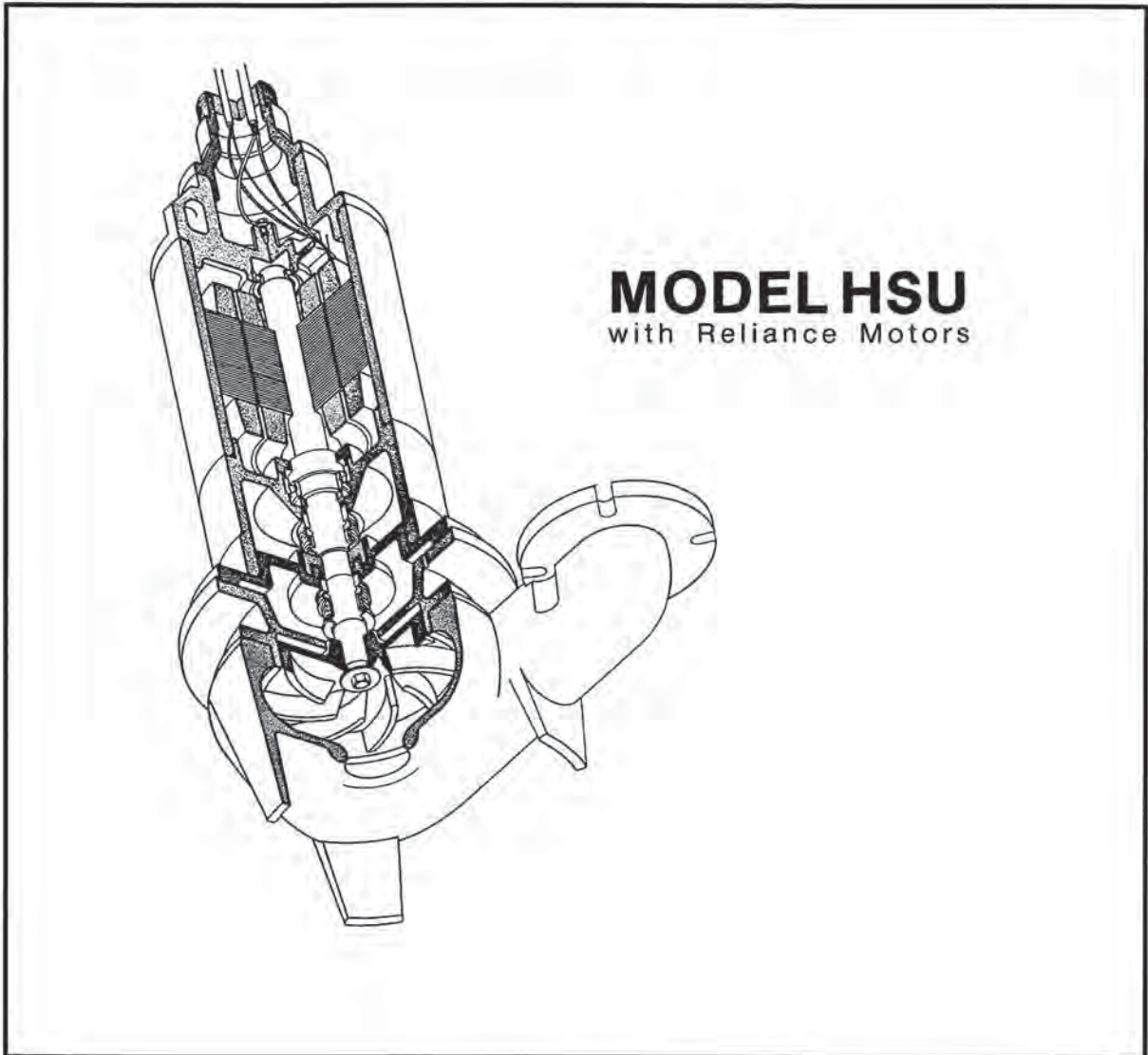

**Manual Number**  
**2377A**



## IMPORTANT SAFETY NOTICE

*To: Our Valued Customers*

User safety is a major focus in the design of our products. Following the precautions outlined in this manual will minimize your risk of injury.

ITT Goulds pumps will provide safe, trouble-free service when properly installed, maintained, and operated.

Safe installation, operation, and maintenance of ITT Goulds Pumps equipment are an essential end user responsibility. This *Pump Safety Manual* identifies specific safety risks that must be considered at all times during product life. Understanding and adhering to these safety warnings is mandatory to ensure personnel, property, and/or the environment will not be harmed. Adherence to these warnings alone, however, is not sufficient — it is anticipated that the end user will also comply with industry and corporate safety standards. Identifying and eliminating unsafe installation, operating and maintenance practices is the responsibility of all individuals involved in the installation, operation, and maintenance of industrial equipment.

Please take the time to review and understand the safe installation, operation, and maintenance guidelines outlined in this Pump Safety Manual and the Instruction, Operation, and Maintenance (IOM) manual. Current manuals are available at [www.gouldspumps.com/literature\\_ioms.html](http://www.gouldspumps.com/literature_ioms.html) or by contacting your nearest Goulds Pumps sales representative.

**These manuals must be read and understood before installation and start-up.**

For additional information, contact your nearest Goulds Pumps sales representative or visit our Web site at [www.gouldspumps.com](http://www.gouldspumps.com).

# SAFETY WARNINGS

Specific to pumping equipment, significant risks bear reinforcement above and beyond normal safety precautions.

---

 **WARNING**

---

A pump is a pressure vessel with rotating parts that can be hazardous. Any pressure vessel can explode, rupture, or discharge its contents if sufficiently over pressurized causing death, personal injury, property damage, and/or damage to the environment. All necessary measures must be taken to ensure over pressurization does not occur.

---

 **WARNING**

---

Operation of any pumping system with a blocked suction and discharge must be avoided in all cases. Operation, even for a brief period under these conditions, can cause superheating of enclosed pumpage and result in a violent explosion. All necessary measures must be taken by the end user to ensure this condition is avoided.

---

 **WARNING**

---

The pump may handle hazardous and/or toxic fluids. Care must be taken to identify the contents of the pump and eliminate the possibility of exposure, particularly if hazardous and/or toxic. Potential hazards include, but are not limited to, high temperature, flammable, acidic, caustic, explosive, and other risks.

---

 **WARNING**

---

Pumping equipment Instruction, Operation, and Maintenance manuals clearly identify accepted methods for disassembling pumping units. These methods must be adhered to. Specifically, applying heat to impellers and/or impeller retaining devices to aid in their removal is strictly forbidden. Trapped liquid can rapidly expand and result in a violent explosion and injury.

ITT Goulds Pumps will not accept responsibility for physical injury, damage, or delays caused by a failure to observe the instructions for installation, operation, and maintenance contained in this Pump Safety Manual or the current IOM available at [www.gouldspumps.com/literature](http://www.gouldspumps.com/literature).

# SAFETY

## DEFINITIONS

Throughout this manual the words **WARNING**, **CAUTION**, **ELECTRICAL**, and **ATEX** are used to indicate where special operator attention is required.

**Observe all Cautions and Warnings highlighted in this Pump Safety Manual and the IOM provided with your equipment.**



### **WARNING**

Indicates a hazardous situation which, if not avoided, could result in death or serious injury.

**Example:** Pump shall never be operated without coupling guard installed correctly.



### **CAUTION**

Indicates a hazardous situation which, if not avoided, could result in minor or moderate injury.

**Example:** Throttling flow from the suction side may cause cavitation and pump damage.



### **ELECTRICAL HAZARD**

Indicates the possibility of electrical risks if directions are not followed.

**Example:** Lock out driver power to prevent electric shock, accidental start-up, and physical injury.









When installed in potentially explosive atmospheres, the instructions that follow the Ex symbol must be followed. Personal injury and/or equipment damage may occur if these instructions are not followed. If there is any question regarding these requirements or if the equipment is to be modified, please contact an ITT Goulds Pumps representative before proceeding.













**Example:**  Improper impeller adjustment could cause contact between the rotating and stationary parts, resulting in a spark and heat generation.



## GENERAL PRECAUTIONS

### WARNING

A pump is a pressure vessel with rotating parts that can be hazardous. Hazardous fluids may be contained by the pump including high temperature, flammable, acidic, caustic, explosive, and other risks. Operators and maintenance personnel must realize this and follow safety measures. Personal injuries will result if procedures outlined in this manual are not followed. ITT Goulds Pumps will not accept responsibility for physical injury, damage or delays caused by a failure to observe the instructions in this manual and the IOM provided with your equipment.

General Precautions		
WARNING		NEVER APPLY HEAT TO REMOVE IMPELLER. It may explode due to trapped liquid.
WARNING		NEVER use heat to disassemble pump due to risk of explosion from tapped liquid.
WARNING		NEVER operate pump without coupling guard correctly installed.
WARNING		NEVER run pump below recommended minimum flow when dry, or without prime.
WARNING		ALWAYS lock out power to the driver before performing pump maintenance.
WARNING		NEVER operate pump without safety devices installed.
WARNING		NEVER operate pump with discharge valve closed.
WARNING		NEVER operate pump with suction valve closed.
WARNING		DO NOT change service application without approval of an authorized ITT Goulds Pumps representative.
WARNING		<p><b>Safety Apparel:</b></p> <ul style="list-style-type: none"> <li>♦ Insulated work gloves when handling hot bearings or using bearing heater</li> <li>♦ Heavy work gloves when handling parts with sharp edges, especially impellers</li> <li>♦ Safety glasses (with side shields) for eye protection</li> <li>♦ Steel-toed shoes for foot protection when handling parts, heavy tools, etc.</li> <li>♦ Other personal protective equipment to protect against hazardous/toxic fluids</li> </ul>
WARNING		<p><b>Receiving:</b></p> <p>Assembled pumping units and their components are heavy. Failure to properly lift and support equipment can result in serious physical injury and/or equipment damage. Lift equipment only at specifically identified lifting points or as instructed in the current IOM. Current manuals are available at <a href="http://www.gouldspumps.com/literature_ioms.html">www.gouldspumps.com/literature_ioms.html</a> or from your local ITT Goulds Pumps sales representative. Note: Lifting devices (eyebolts, slings, spreaders, etc.) must be rated, selected, and used for the entire load being lifted.</p>
WARNING		<p><b>Alignment:</b></p> <p>Shaft alignment procedures must be followed to prevent catastrophic failure of drive components or unintended contact of rotating parts. Follow coupling manufacturer's coupling installation and operation procedures.</p>

<b>General Precautions</b>		
<b>WARNING</b>		Before beginning any alignment procedure, make sure driver power is locked out. Failure to lock out driver power will result in serious physical injury.
<b>CAUTION</b>		<b>Piping:</b> Never draw piping into place by forcing at the flanged connections of the pump. This may impose dangerous strains on the unit and cause misalignment between pump and driver. Pipe strain will adversely effect the operation of the pump resulting in physical injury and damage to the equipment.
<b>WARNING</b>		<b>Flanged Connections:</b> Use only fasteners of the proper size and material.
<b>WARNING</b>		Replace all corroded fasteners.
<b>WARNING</b>		Ensure all fasteners are properly tightened and there are no missing fasteners.
<b>WARNING</b>		<b>Startup and Operation:</b> When installing in a potentially explosive environment, please ensure that the motor is properly certified.
<b>WARNING</b>		Operating pump in reverse rotation may result in contact of metal parts, heat generation, and breach of containment.
<b>WARNING</b>		Lock out driver power to prevent accidental start-up and physical injury.
<b>WARNING</b>		The impeller clearance setting procedure must be followed. Improperly setting the clearance or not following any of the proper procedures can result in sparks, unexpected heat generation and equipment damage.
<b>WARNING</b>		If using a cartridge mechanical seal, the centering clips must be installed and set screws loosened prior to setting impeller clearance. Failure to do so could result in sparks, heat generation, and mechanical seal damage.
<b>WARNING</b>		The coupling used in an ATEX classified environment must be properly certified and must be constructed from a non-sparking material.
<b>WARNING</b>		Never operate a pump without coupling guard properly installed. Personal injury will occur if pump is run without coupling guard.
<b>WARNING</b>		Make sure to properly lubricate the bearings. Failure to do so may result in excess heat generation, sparks, and / or premature failure.
<b>CAUTION</b>		The mechanical seal used in an ATEX classified environment must be properly certified. Prior to start up, ensure all points of potential leakage of process fluid to the work environment are closed.
<b>CAUTION</b>		Never operate the pump without liquid supplied to mechanical seal. Running a mechanical seal dry, even for a few seconds, can cause seal damage and must be avoided. Physical injury can occur if mechanical seal fails.
<b>WARNING</b>		Never attempt to replace packing until the driver is properly locked out and the coupling spacer is removed.
<b>WARNING</b>		Dynamic seals are not allowed in an ATEX classified environment.
<b>WARNING</b>		DO NOT operate pump below minimum rated flows or with suction and/or discharge valve closed. These conditions may create an explosive hazard due to vaporization of pumpage and can quickly lead to pump failure and physical injury.

<b>General Precautions</b>		
<b>WARNING</b>		Ensure pump is isolated from system and pressure is relieved before disassembling pump, removing plugs, opening vent or drain valves, or disconnecting piping.
<b>WARNING</b>		<b>Shutdown, Disassembly, and Reassembly:</b> Pump components can be heavy. Proper methods of lifting must be employed to avoid physical injury and/or equipment damage. Steel toed shoes must be worn at all times.
<b>WARNING</b>		The pump may handle hazardous and/or toxic fluids. Observe proper decontamination procedures. Proper personal protective equipment should be worn. Precautions must be taken to prevent physical injury. Pumpage must be handled and disposed of in conformance with applicable environmental regulations.
<b>WARNING</b>		Operator must be aware of pumpage and safety precautions to prevent physical injury.
<b>WARNING</b>		Lock out driver power to prevent accidental startup and physical injury.
<b>CAUTION</b>		Allow all system and pump components to cool before handling them to prevent physical injury.
<b>CAUTION</b>		If pump is a Model NM3171, NM3196, 3198, 3298, V3298, SP3298, 4150, 4550, or 3107, there may be a risk of static electric discharge from plastic parts that are not properly grounded. If pumped fluid is non-conductive, pump should be drained and flushed with a conductive fluid under conditions that will not allow for a spark to be released to the atmosphere.
<b>WARNING</b>		Never apply heat to remove an impeller. The use of heat may cause an explosion due to trapped fluid, resulting in severe physical injury and property damage.
<b>CAUTION</b>		Wear heavy work gloves when handling impellers as sharp edges may cause physical injury.
<b>CAUTION</b>		Wear insulated gloves when using a bearing heater. Bearings will get hot and can cause physical injury.



## ATEX CONSIDERATIONS and INTENDED USE

Special care must be taken in potentially explosive environments to ensure that the equipment is properly maintained. This includes but is not limited to:

1. Monitoring the pump frame and liquid end temperature.
2. Maintaining proper bearing lubrication.
3. Ensuring that the pump is operated in the intended hydraulic range.

The ATEX conformance is only applicable when the pump unit is operated within its intended use. Operating, installing or maintaining the pump unit in any way that is not covered in the Instruction, Operation, and Maintenance manual (IOM) can cause serious personal injury or damage to the equipment. This includes any modification to the equipment or use of parts not provided by ITT Goulds Pumps. If there is any question regarding the intended use of the equipment, please contact an ITT Goulds representative before proceeding. Current IOMs are available at [www.gouldspumps.com/literature\\_ioms.html](http://www.gouldspumps.com/literature_ioms.html) or from your local ITT Goulds Pumps Sales representative.

All pumping unit (pump, seal, coupling, motor and pump accessories) certified for use in an ATEX classified environment, are identified by an ATEX tag secured to the pump or the baseplate on which it is mounted. A typical tag would look like this:



The CE and the Ex designate the ATEX compliance. The code directly below these symbols reads as follows:

- II = Group 2
- 2 = Category 2
- G/D = Gas and Dust present
- T4 = Temperature class, can be T1 to T6 (see Table 1)

<b>Code</b>	<b>Max permissible surface temperature °F (°C)</b>	<b>Max permissible liquid temperature °F (°C)</b>
T1	842 (450)	700 (372)
T2	572 (300)	530 (277)
T3	392 (200)	350 (177)
T4	275 (135)	235 (113)
T5	212 (100)	Option not available
T6	185 (85)	Option not available

The code classification marked on the equipment must be in accordance with the specified area where the equipment will be installed. If it is not, do not operate the equipment and contact your ITT Goulds Pumps sales representative before proceeding.

# PARTS



The use of genuine Goulds parts will provide the safest and most reliable operation of your pump. ITT Goulds Pumps ISO certification and quality control procedures ensure the parts are manufactured to the highest quality and safety levels.

Please contact your local Goulds representative for details on genuine Goulds parts.

---

## **I. GENERAL**

### **A. INTRODUCTION**

This instruction manual is intended to assist those involved with the installation, operation and maintenance of Goulds SPD slurry pumps. It is recommended that this manual be thoroughly reviewed prior to installing or performing any work on the pump or motor.

### **B. IMPORTANCE OF INSTRUCTIONS**

The design, material and workmanship incorporated in the construction of Goulds SPD slurry pumps makes them capable of giving long, trouble-free service. The life and satisfactory service of any mechanical unit, however, is enhanced and extended by periodic inspection and careful maintenance. This manual was prepared to assist operators in understanding the construction and correct methods of installing, operating, and maintaining these pumps.

Keep this manual handy for reference. Further information can be obtained by contacting the Slurry Pump Division, P.O. Box 419, Baldwinsville, New York, 13027.

### **C. SPECIAL WARNINGS**

Goulds Slurry Pump Division will not be liable for any damages or delay caused by failure to comply with the provisions of this instruction manual. This pump is not to be operated at speeds, working pressures, discharge pressures, or temperatures higher than, nor used with liquids other than, stated in the original order acknowledgement, without written permission of the Slurry Pump Division, Goulds Pumps, Inc.

### **D. RECEIVING INSPECTION - SHORTAGES**

Care should be taken when unloading pumps. If shipment is not delivered in good order and in accordance with the bill of lading, note the damage or shortage on both receipt and freight bill. **MAKE ANY CLAIMS TO THE TRANSPORTATION COMPANY PROMPTLY.**

### **E. PRESERVATION AND STORAGE**

Goulds Slurry Pump Division's normal domestic shipping and storage preparation is suitable for protecting the pump during shipment in covered trucks. Although this is a submersible

pump, storage in a clean, dry area will help preserve the paint and prevent corrosion. Hand rotation of the shaft every thirty days is recommended to keep the seals free and the bearings lubricated.

## **II. SUMP INSTALLATION**

The sump floor should be level and firm where the pump will be placed. Make sure the sump and sump inlet line are free from large pieces of debris which could eventually obstruct the pump inlet.

## **III. MOTOR INSTALLATION**

The motor is furnished with thermal protection and a moisture probe. Wire the motor according to the motor manufacturer's wiring diagram. Re-check the protective circuits after the wiring is completed to avoid a possible motor failure because of an oversight.

The motor has to be completely submerged for continuous operation. It can be operated for a maximum of 15 minutes without being submerged. The sump controls should be set to allow a maximum possible run of 15 minutes after the motor is no longer completely submerged if the sump is large enough to not have completed the pump-down in that time.

The motor is rated for full horsepower with liquid temperatures of 40° C. (104° F.) or lower.

## **IV. PUMP INSTALLATION**

Make sure the lifting device is securely fastened to the motor lugs or hooks so the unit will not be dropped when it is lowered into the sump. Check the 1/8" vent hole in the adapter plate, between the motor and the casing, to make certain it is not plugged and then carefully lower the unit into position in the sump. Check the pump for being approximately level. Support the discharge pipe to prevent excessive loads from being transmitted to the pump flange and casing.

## V. STARTING THE PUMP

The most important concern is the prevention of motor overloading. Refer to the motor nameplate for the full load ampere rating of the motor. Install an ammeter on the motor leads and check the motor draw immediately after the unit is started.

An excessive current draw with a 3-phase motor is an indication of wrong rotation. Observe the discharge for flow rate, then change two of the three motor leads to reverse the direction of rotation. If the rotation was wrong, the current draw will be reduced at the same or greater flow rate. Single phase motors are internally wired for the correct rotation.

The ammeter on the motor leads should be checked for overload at all sump level heights with the liquid that will be normally pumped to check for motor overload at some other condition from that encountered at start-up. The horsepower will tend to increase as the level in the sump rises.

## VI. LOCATING TROUBLE

Insufficient or no discharge can be caused by any of the following conditions:

1. Speed too low (usually due to low voltage)
2. System head too high
3. Insufficient NPSH or submergence
4. Wear of the pump parts
5. Wrong direction of rotation
6. Pump not completely primed (plugged vent hole)
7. Suction opening or discharge pipe clogged
8. Viscosity of slurry too high

## VII. EXCESSIVE CURRENT DRAW

Excessive current draw may be caused by any of the following conditions:

1. Wrong direction of rotation
2. Pump operating at a high horsepower area of the pump curve (capacity is greater than the design capacity)
3. Impeller rubbing or mechanical defect in the motor
4. Specific gravity or viscosity too high.
5. Low voltage

Typical PARTS LIST		
ITEM	QTY/ PUMP	PART NAME
100	1	CASING
101	1	IMPELLER
211	1	GASKET
340	1	MOTOR ADAPTER, or Mount
351	1	GASKET
357	8	HEX NUT
357A	①	HEX NUT
370C	1	HEX CAP SCREW, IMPELLER
370R	8	HEX CAP SCREW
371W	①	HEX CAP SCREW
528J	1	WASHER
528L	8	WASHER
528M	①	WASHER
9700	1	MOTOR

- ① Parts 357A, 371W and 528M, 8 each, furnished only with 3x3-8 with 180TY and 210TY motors.

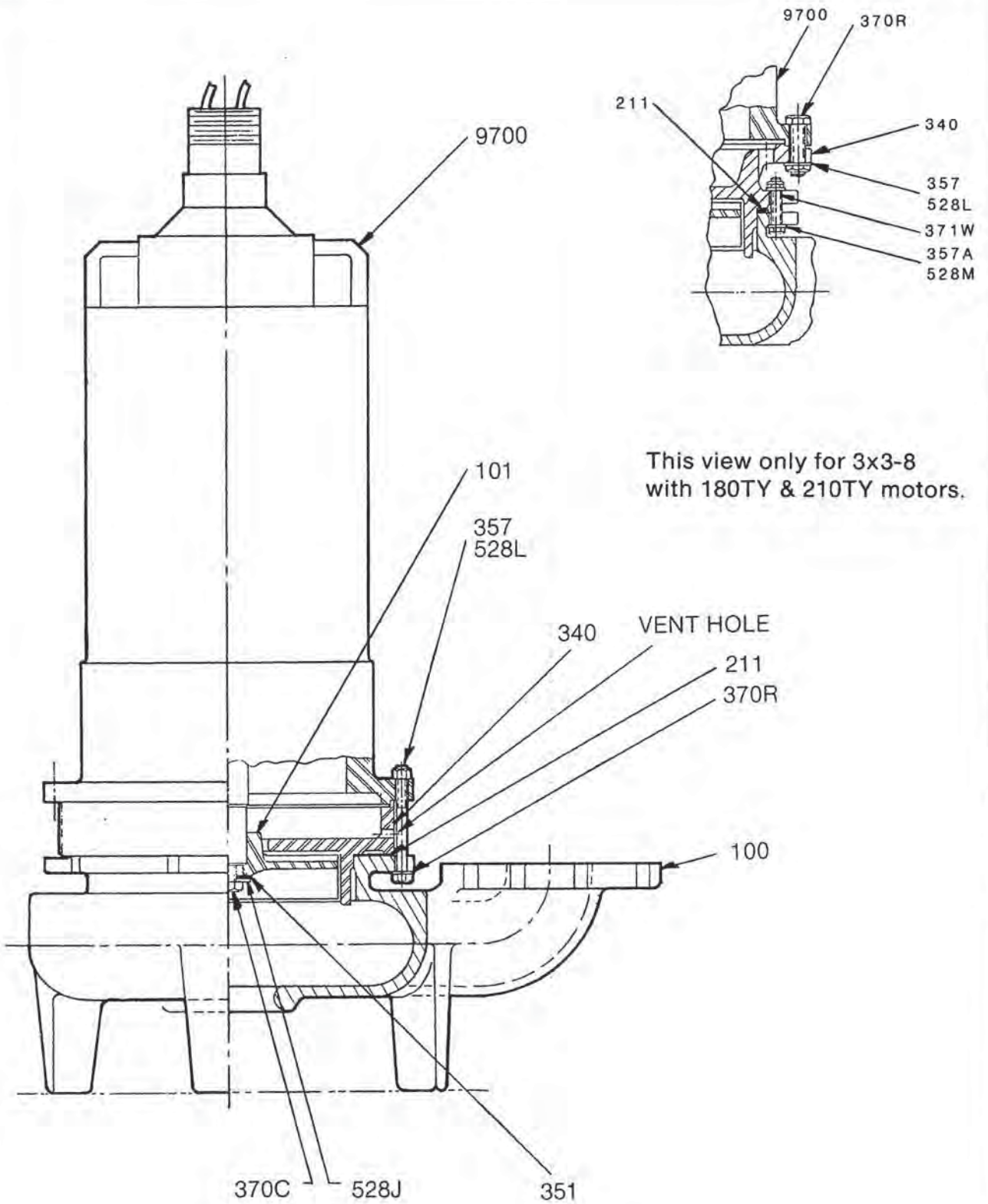

(COO827G)

**Model HSU**  
SECTIONAL ASSEMBLY

## VIII. DISASSEMBLY AND ASSEMBLY

In the sectional assembly in this instruction, it should be noted that the motor adapter configuration varies with the motor frame. The various fastening arrangements are shown. Refer to the bill of material and sectional assembly certified for your order.

### A. DISASSEMBLY

1. Disconnect all electrical service. Mark leads for reassembly.
2. (a) For 3x3-8 pumps fitted with 180TY and 210TY motors, remove bolts 371W. Loosening nut 357A should be sufficient to permit sliding bolt, nut and washer 528M out of slot. Pull casing from motor fit.  
(b) For pumps other than those listed in 2(a), remove bolts 370R, nut 357 and washer 528L. Pull casing from adapter fit. The adapter will be loose. Clamp or block the adapter so that it stays in the fit.
3. Remove cap screw 370C, washer 528J and gasket 351 which secure impeller 101 to motor shaft. Impeller is keyed on shaft and should be removed by pulling.
4. (a) For 3x3-8 pumps fitted with 180TY and 210TY motors, remove bolts 370R fastening motor adapter 340 and motor flange. Separate motor from motor adapter fit.  
(b) For pumps other than those listed in 4(a), separate adapter from motor, being careful not to let adapter hit seal on motor shaft.

**NOTE: THE MOTOR SHALL BE DISASSEMBLED ONLY BY AN AUTHORIZED REPAIR CENTER. FAILURE TO COMPLY WILL RESULT IN VOIDING OF WARRANTY.**

FOR MOTOR INSTRUCTIONS SEE RELIANCE ELECTRIC MANUAL B-3629.

### B. ASSEMBLY

- Check the vent hole in the adapter 340 to be sure it is clear.
1. (a) For 3x3-8 HSU pumps fitted with 180TY or 210TY motors, align the motor in the adapter 340 fit and secure with bolts 370R and washers 528L and nuts 357.  
(b) For pumps other than mentioned in 1(a), clamp or block adapter 340 in position to motor flange. Be careful not to damage seal on motor shaft.

2. Clean shaft and impeller bore, being sure they are free of burrs.
3. Install key and impeller on the motor shaft. Be sure end of shaft bottoms in impeller bore. Install gasket 351. Secure with washer 528J and cap screw 370C.
4. (a) For 3x3-8 pumps fitted with 180TY and 210TY motors, guide 100 into fit of adapter and secure with bolts 371W, washers 528M and nuts 357A.  
(b) For pumps other than those in 4(a), secure casing and adapter to motor with cap screw 370R, washers 528L and nuts 357.
5. When connecting electrical service, be sure polarity is correct to give clockwise rotation when looking down on motor.

## IX. SPARE PARTS

### A. ORDERING SPARE PARTS

To insure against possible long and costly downtime periods, especially on critical services, it is advisable to have spare parts on hand.

Parts orders will be handled most promptly if the following directions are followed.

1. Include pump model and size and its serial number as shown on the nameplate.
2. For each part required include the name and part number as shown on the bill of material.
3. State the quantity required of each part.
4. Provide complete shipping instructions.

### B. RECOMMENDED SPARES

The following are pump application categories and their recommended spare parts.

1. Normal Duty - Random mildly abrasive particles.  
Recommended spare parts:  
1 Gasket Set
2. Heavy Duty - Slurries over 1.2 specific gravity with highly abrasive materials.  
Recommended spare parts:  
1 Gasket Set  
1 Impeller  
1 Outer Mechanical Seal, from Reliance Electric.





**ITT**